

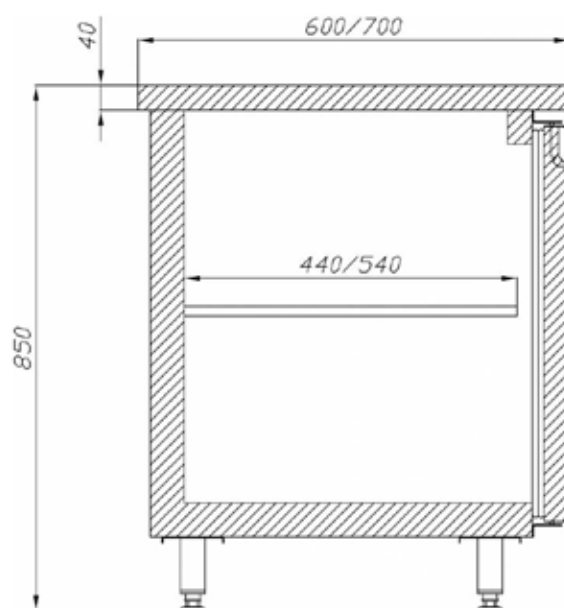









Cooling Working Tables - J-JK-73



J-JK-73*



Technical parameters:

Models	Dimension (ext.) H x W x D [mm]	Doors	Shelves	Drawers	Capacity [dm ³]	Power Consumption [kWh/24h]	Weight [kg]	Doors Drawers options
J-JK-73 1.3	850 x 1300 x 700	2	2	0	300	2,20	110	
J-JK-73 1.3 2DRW	850 x 1300 x 700	1	1	2	300	2,20	110	
J-JK-73 1.3 4DRW	850 x 1300 x 700	0	0	4	300	2,20	110	
J-JK-73 1.4	850 x 1400 x 700	2	2	0	350	2,30	120	
J-JK-73 1.4 2DRW	850 x 1400 x 700	1	1	2	350	2,30	120	
J-JK-73 1.4 4DRW	850 x 1400 x 700	0	0	4	350	2,30	120	
J-JK-73 1.5	850 x 1500 x 700	2	2	0	400	2,40	130	
J-JK-73 1.5 2DRW	850 x 1500 x 700	1	1	2	400	2,40	130	
J-JK-73 1.5 4DRW	850 x 1500 x 700	0	0	4	400	2,40	130	

* - Picture above presents unit with either some or all available extras. Please note that the look of basic version of cabinet, or one of your choice, may vary from presented.

Cooling Working Tables - J-JK-73



J-JK-73*

Description:

- temperature range +1 / +10°C
- preferred ambient temperature +16 / +25°C
- power supply 230V / 50Hz
- internal condensing unit
- interior and body made of stainless steel
- stainless steel worktop (40mm thick)
- electronic control with temperature display
- automatic defrost and evaporation system
- forced air circulation
- 1 year full warranty service and after warranty service provided

Available options:

- 600mm deep version
- granite worktop 30mm thick - optional colours
- additional shelf with guide

Optional colours:



* - Picture above presents unit with either some or all available extras. Please note that the look of basic version of cabinet, or one of your choice, may vary from presented.